

Enclosure series technoDISC

Type: TD 100

Material-No.: 285.100.000

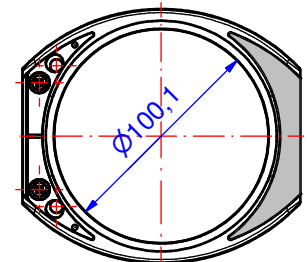
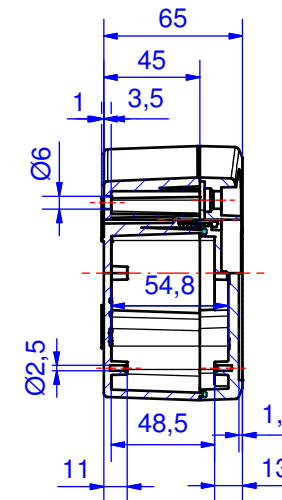
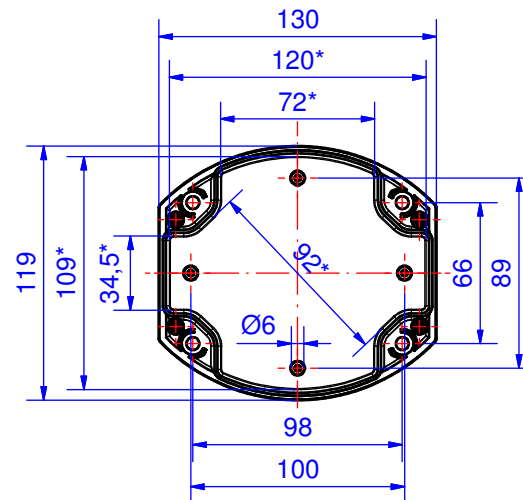
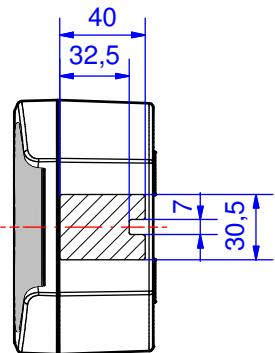
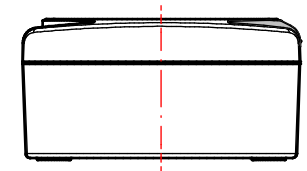
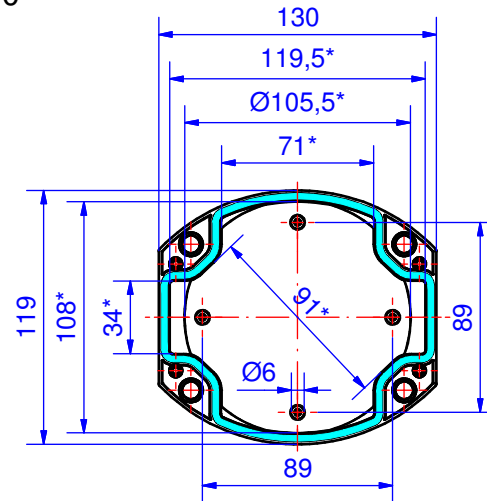

Folie/ Keypad
Ø99,9⁺⁰_{-0,2}

* Please note: Mould slope for casting ejection, dimensions in the amount of the bottom!

Enclosure material	ASA Luran S, RAL 7035, light grey		Gasket	1x moulded gasket, silicone, transparent
Lid screws	4x 1.4567 (V2A), captive		Ingress protection	IP66 EN 60529
Assembly screws	4x KBL Ø3x8,5, galvanized steel		Weight	350 g
Design covers	2x Polyoxymethylene (POM), RAL 7016, anthracite grey		Tolerance	DIN ISO 16901-130 (outside dimensions ±0,5mm)

285.100.000
technoDISC TD 100



Product overview

Material	ASA LURAN
Protection Class	IP 66/EN 60529, IP 67/EN 60529
Color	RAL 7035
Certifications	GOST
Length (L)	130 mm
Width (W)	119 mm
Height (H)	65 mm
Weight (g)	350 g

technoDISC

THE THERMOPLASTIC DESIGN ENCLOSURE FOR ELECTRONICS & DEVICES

IP 66 - Optional: IP 67

The key product features:

- Enclosure material: ASA + PC
- Enclosure colour similar to RAL 7035
- Clip-on Design covers
- The enclosure can be mounted when the lid is fitted
- Integrated recess to accommodate membrane keypad or front plate
- Fastening options in the enclosure bottom for internal mountings
- Lid screws stainless steel 1.4567
- Fire protection class UL-94 V0
- Enclosure seal: silicone moulded seal

technoDISC is a unique range of high performance plastic enclosures for industrial electronics. It is especially ideal for Industry 4.0 and IIOT applications.

The enclosures have a modern and highly attractive individual appearance with no visible fixing screws. Dark grey snap-on lid trims hide all of the assembly and mounting screws — providing tamper protection. The lid is recessed for locating a membrane keypad, front plate or product label.

technoDISC is available in four standard sizes with plenty of space inside for PCBs and electronic components. The enclosure can be mounted without opening the lid using the separate mounting channels (protecting the electronics inside). Screw pillars are moulded in the lid and base sections for fitting PCBs, mounting plates and electronic assemblies.

Accessory lid retaining straps, internal mounting plates and cable glands are available.

Enclosure sizes

4

Further information

Integrated recesses for membrane keypads or front plates

Functional and extensive range of accessories

Enclosure

ASA+PC, similar to RAL 7035 light grey

Special material on request

2° mould slope for casting ejection, internal circumference dimensions decrease by 2° towards the enclosure base

Clip-on design covers, plastic polyoxymethylene (POM), RAL 7016 anthracite grey

Flammability

UL 94 V-0

Fastening

Separate screw channels outside of the enclosure interior, enclosure to be fastened while the lid is closed

Internal mountings

Fastening option for self-grooving screws on the base of the enclosure and in the lid

Ingress protection

IP 66 / EN 60529

Optional: IP 67 / EN 60529

Gasket

Silicone moulded gasket

Optional: EMC gasket

Lid screws

Stainless steel 1.4567, captive

ROLEC Service

Utilise our [full service offer for installation-ready enclosures](#)

Full-Service-Products

Customization according to your wishes.



Our passion is enclosures.



Expert advice

Everything begins with individual advice. We'll be pleased to support you with your project and find solutions for every requirement. Customer-specific solutions are our speciality.



Sample service

Test our products with your internal mounting. We'll be pleased to send you a sample enclosure for inspection with no strings attached.



Drilling

We'll manufacture every enclosure for you according to your exact specifications – whether they involve precise drilling or large tolerance.



Milling

Thanks to our modern CNC production, we can quickly and efficiently mill custom-fit cut-outs and contours to match your exact specifications.



Engraving

Our services also include engraving your logo and other elements, which we can of course perform in any colour you desire.



Lasering

We can process stainless steel enclosures and plates quickly and reliably according to your individual requirements thanks to our in-house lasering centre.



Powder coating

We can powder coat enclosures, command enclosures and suspension systems in any RAL colour you desire. Custom colours are of course also possible.



Painting

We can also paint all our enclosures in any RAL colour you desire. The application of primer and special colour structures are possible, as well.



Serigraphy

If desired, we can apply your logo and lettering or other markings using serigraph printing.



Digital printing

Digital printing is particularly worthwhile for low-volume orders and for realising complex patterns or images.



EMC enclosures

We offer our conFORM low-price standard EMC enclosure to protect your internal mounting against electromagnetic radiation. On request, we can also supply an EMC-compliant version of any other ROLEC enclosure.



Displays

We are able to offer the right made-to-measure display for all our enclosures – in varying sizes and degrees of robustness depending on the application.



Accessories

ROLEC's portfolio also includes matching front plates, mounting plate, supporting rails and terminal blocks as well as a range of cable glands, blanking plugs etc.



Assembly

Would you like to have all your components supplied already assembled? No problem. Our assembly team will be pleased to perform all assembly work on your behalf.



Our Service

If you have any requirements for services not listed here, please ask us. Customer-specific solutions are our speciality. We also are keen to take on unusual tasks.

We will help you with those challenges that many others would give up on.