

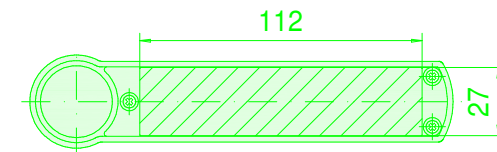

# Enclosure series mobilCASE

Type: P 130-1

Material-No.: 250.130.180, Length (L) of profile variable

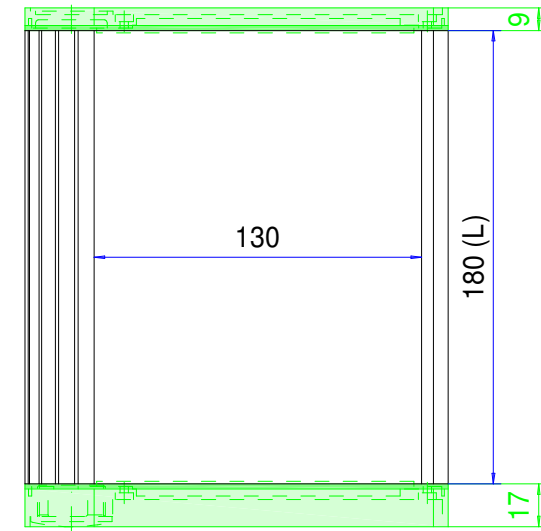
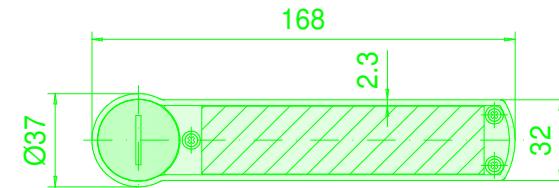

Enclosure material	Al Mg Si 0.5 (DIN 17615)		Ingress protection	IP65 EN 60529
Lid material	GD-Zn Al 4 Cu 1 (DIN EN 12844)		Weight	Profile 2,014 kg/m
Lid screws	6x stainless steel 1.4567 (V2A), captive		Coating profile	Powder coating silver metallic
Gasket lid	2x TPE moulded gasket, siliconefree, black		Coating lid	Powder coating RAL 9005, black
			Tolerance	GTA 13/5 DIN 1688-4 (outside dimensions ±0,5mm)

**250.130.180**  
**mobilCASE 1-Part Profile P 130-1-180**

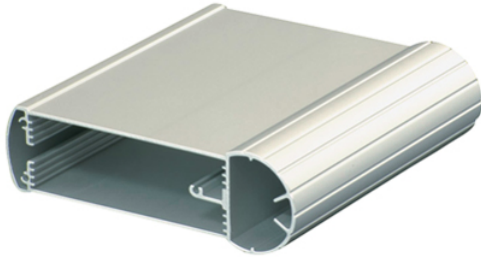

**Product overview**

Material	Aluminium
Protection Class	IP 65 EN 60529
Color	Silver 1
Certifications	GOST
Length (L)	180 mm
Width (W)	168 mm

## **mobilCASE**

### THE MOBILE, PROFILE CONTROL ENCLOSURE

#### **IP 54 / IP 65**

#### **The key product features:**

- Enclosure material: aluminium profile
- Lid material: diecast zinc
- Enclosure surface: Profile silver-metallic, Lid RAL 9005
- Available as 1-part and 2-part profile
- Lid screws stainless steel 1.4567
- 1-part profile for the insertion of circuit boards
- 2-part profile for the easy assembly of short-stroke keyboards or displays
- Integrated recess for a membrane keypad or front membrane
- Ingress protection: 1-piece profile IP 65; 2-piece profile IP 54
- Lid gasket: TPE moulded gasket, silicone-free, Gasket, 2-part profile: O-ring gasket (CR)

---

mobilCASE is a modern and ergonomic range of extruded enclosures which is ideal for handheld electronic instruments and mobile machine/robotic controllers. Three standard widths are available to suit a wide range of applications. The enclosures can be supplied in custom lengths on demand. Each enclosure consist of a case profile and two end covers which are supplied with TPE moulded sealing gaskets and a screw kit. There are various types of end cover kits and accessories to suit different uses and installation set-ups. The enclosures are specified from individual kits.

#### **HOW TO CONFIGURE YOUR mobilCASE ENCLOSURES**

##### **1). Enclosure Profile**

Select the size and type of enclosure profile you need from the table below (click on part no.). The profiles are specified in PCB widths: 80, 100 and 130 mm (Dim. P). Types: 1-Part (IP 65) single profile for slide-in PCBs or 2-Part (IP 54) open profile which allows for keypads, displays etc. to pass through the top (when machined).

##### **2). End Covers Kit**

Select a suitable end cover kit from the accessories section. All cover kits include two TPE moulded seals and a screw kit. Options:

Set DF - two flat end covers    Set DK - one flat and one deep end cover with M16 screw plug (for battery compartment access)    Set ABF - adjustable tilt stand with two flat end covers    Set ABK - adjustable tilt stand with one flat and one deep end cover with M16 screw plug    Set WH - wall/machine pivot mount bracket with two flat end covers    Set PG - two rotating end covers for connecting two units together.

Select any optional accessories:

Set PK - shoulder strap with two protection caps for carrying the unit    Set CH - case holder for storing the unit on a wall or machine    Set AH - battery holders for 2 or 4 1.5V AA cells    Set KV - M16 cable gland adaptor kit (replaces screw plug on deep end covers).

##### **CONFIGURATOR**

You can also specify these enclosures in custom sizes using the [mobilCASE configurator](#).

##### **CUSTOMIZED VERSIONS**

We can supply mobilCASE enclosures fully **machined and finished to your requirements**.

#### **Enclosure profiles**

3 standard PCB widths (Dim. P: 80 mm, 100 mm, 130 mm) in 2 versions

### **Additional info**

- Integrated recess in the profiles for a membrane keypad or product label
- Die-cast flat end covers or deep end covers with collar to protect plug connectors
- Optional: Adapter with M16 cable gland for external power supply
- Optional: Case holder for storing the unit on the wall or machine
- Optional: Combination kit for connecting two profiles (also with different sections)
- Optional: Shoulder strap with protective caps for portable instruments
- Optional: Adjustable tilt stand kits including end covers
- Optional: Battery holders for 2 or 4 AA batteries

### **Material/colour**

- Extruded aluminium profile: AL Mg Si 0.5 / DIN 17615
- Powder coating, silver metallic
- Optional: Anodised
- End cover (2 variants): Die-cast zinc alloy GD-Zn Al 4 Cu 1 / DIN EN 12844
- Powder coating, RAL 9005, deep black
- Optional: Special colours

### **Fastening**

- Optional: Clip holder for setting down devices at the wall or machine
- Optional: Articulated wall/desk fixation including stand

### **Internal mounting**

- For circuit board widths 80 mm/100 mm (Eurocard)/130mm

### **Ingress protection**

- Profile 1-part IP 65 / EN 60529
- Profile 2-part IP 54 / EN 60529
- Set PG IP 54 / EN 60529

### **Gasket**

- Lid: TPE moulded gasket, silicone-free
- Profile: Chloroprene O-ring gasket (CR)

### **Lid screws**

- Stainless steel 1.4567

### **Customising**

- Learn more about our [full customising service for installation-ready enclosures](#)

# Full-Service-Products

Customization according to your wishes.



Our passion is enclosures.



Expert advice

Everything begins with individual advice. We'll be pleased to support you with your project and find solutions for every requirement. Customer-specific solutions are our speciality.



Sample service

Test our products with your internal mounting. We'll be pleased to send you a sample enclosure for inspection with no strings attached.



Drilling

We'll manufacture every enclosure for you according to your exact specifications – whether they involve precise drilling or large tolerance.



Milling

Thanks to our modern CNC production, we can quickly and efficiently mill custom-fit cut-outs and contours to match your exact specifications.



Engraving

Our services also include engraving your logo and other elements, which we can of course perform in any colour you desire.



Lasering

We can process stainless steel enclosures and plates quickly and reliably according to your individual requirements thanks to our in-house lasering centre.



Powder coating

We can powder coat enclosures, command enclosures and suspension systems in any RAL colour you desire. Custom colours are of course also possible.



Painting

We can also paint all our enclosures in any RAL colour you desire. The application of primer and special colour structures are possible, as well.



Serigraphy

If desired, we can apply your logo and lettering or other markings using serigraph printing.



Digital printing

Digital printing is particularly worthwhile for low-volume orders and for realising complex patterns or images.



EMC enclosures

We offer our conFORM low-price standard EMC enclosure to protect your internal mounting against electromagnetic radiation. On request, we can also supply an EMC-compliant version of any other ROLEC enclosure.



Displays

We are able to offer the right made-to-measure display for all our enclosures – in varying sizes and degrees of robustness depending on the application.



Accessories

ROLEC's portfolio also includes matching front plates, mounting plate, supporting rails and terminal blocks as well as a range of cable glands, blanking plugs etc.



Assembly

Would you like to have all your components supplied already assembled? No problem. Our assembly team will be pleased to perform all assembly work on your behalf.



Our Service

If you have any requirements for services not listed here, please ask us. Customer-specific solutions are our speciality. We also are keen to take on unusual tasks.

We will help you with those challenges that many others would give up on.