

Enclosure series aluCASE

Type: ACF 110

Material-No.: 190.110.000

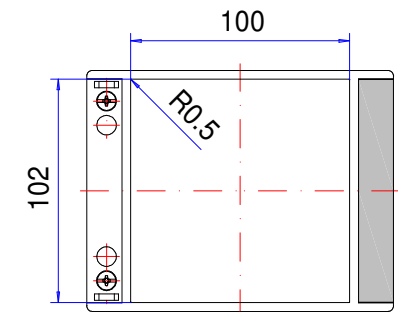
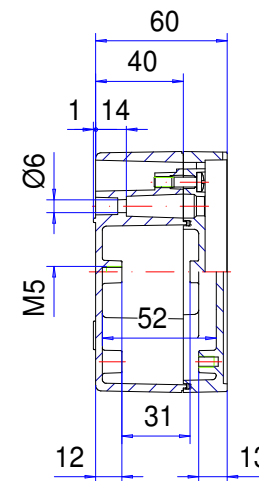
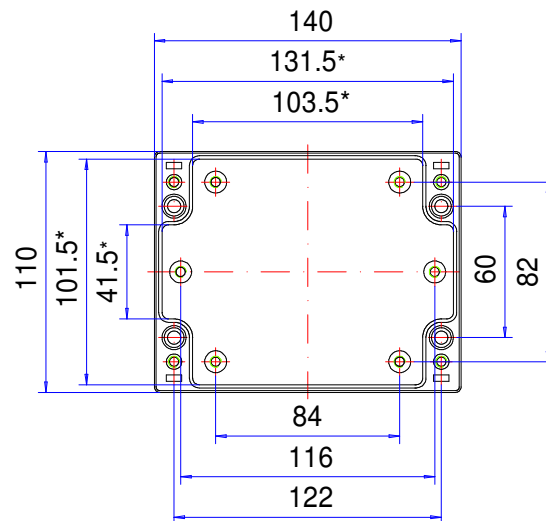
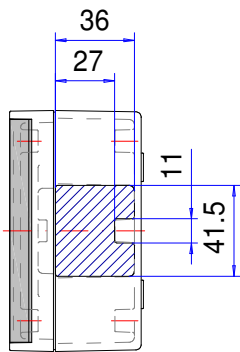
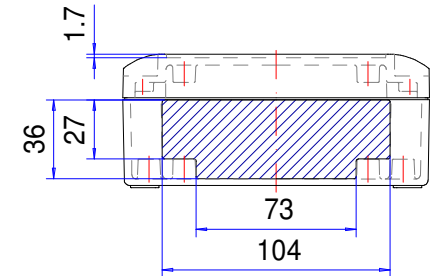
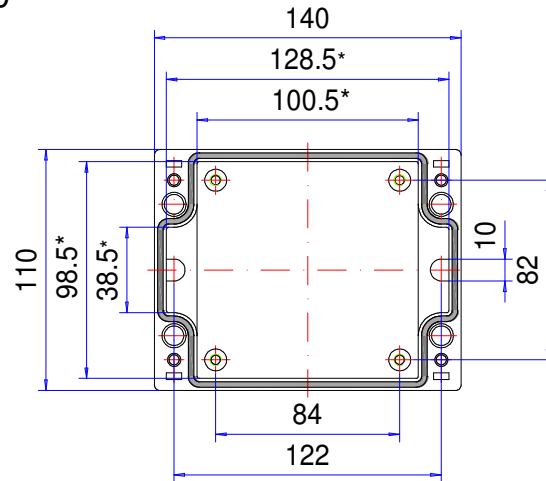

Folie/ Keypad
101.4⁺⁰_{-0.2} x 99.4⁺⁰_{-0.2}

* Please note: Mould slope for casting ejection, dimensions in the amount of the bottom!

Enclosure material	GD-Al Si 12 (DIN 1725)		Gasket	1x TPE moulded gasket, silicone-free, black
Lid screws	4x stainless steel 1.4567 (V2A), captive		Ingress protection	IP67 EN 60529
Assembly screws	5x M5x8, galvanized steel		Weight	700 g
Design covers	2x Polyoxymethylene (POM), RAL 7040, window grey		Coating	Powder coating RAL 7040, window grey
Lid supports	2x Polypropylene (PP), window grey		Tolerance	GTA 13/5 DIN 1688-4 (outside dimensions ±0,5mm)

190.110.000
aluCASE ACF 110



Product overview

Material	Aluminium
Protection Class	IP 67/EN 60529, IP 69K
Color	RAL 7040
Certifications	CSA (optional), UL (optional), Germanischer Lloyd (optional), GOST
Length (L)	140 mm
Width (W)	110 mm
Height (H)	60 mm
Weight (g)	700 g

aluCASE

THE PREMIUM ENCLOSURE FOR ELECTRONICS & DEVICES

IP 66, IP 67 - Optional: IP 69K

The key product features:

- Enclosure material: diecast aluminium
- Enclosure surface: powder coating, RAL 7040
- Integrated lid support
- Transparent lid for the sizes AC 092K and ACF 110K
- Enclosure can be mounted even when the lid is fitted
- Integrated recess in lid for membrane keypad or front plate
- Clip-on design covers
- Lid screws in stainless steel 1.4567
- Enclosure seal: TPE moulded gasket, PUR

aluCASE is a highly attractive and very versatile range of diecast aluminium enclosures for industrial electronics. The design is perfect for mounting to a wall or a machine, or for use as a mobile instrument. The enclosures are sealed to IP 67 for indoor and outdoor applications. Hot jet wash IP 69K is also available. The enclosures can be mounted without opening the lid which means your electronics remain protected at all times. Whatever the application, aluCASE provides the very best housing solution for your components.

Designer features include a recessed lid, for fitting a membrane keypad, front plate or product label, clip-on design covers in plastic or aluminium that hide the lid screws and mounting holes, integrated hinges and lid retaining straps (on most models). Two versions are available with transparent lids. Threaded screw bosses are provided in the base and lid for PCBs, mounting plates, DIN rails etc. Cable glands and other accessories are also available.

We can supply aluCASE enclosures fully customised to your requirements.

Enclosure sizes

29

Additional info

Can be fastened while enclosure is closed

Integrated recess in the lid for a membrane keypad, front plate or label

Integrated PP (polypropylene) lid support strap

2 sizes available with transparent lids

Clip-on design covers, standard: Plastic POM (polyoxymethylene), similar to RAL 7040 window grey

Optional: Anodised aluminium design covers

Optional: Exterior hinges made from anodised aluminium with no visible outer screws

Enclosure

Diecast aluminium alloy

EN AN-44300 DIN EN 1706

(GD Al Si 12/DIN 1725)

1° mould slope for casting ejection > internal circumference dimensions decrease by 1° towards enclosure bottom.

Fastening

Separate screw channels

Internal mounting

M5 fastening thread on the enclosure base and in the lid

Ingress protection

IP 66, IP 67 / EN 60529

Optional: IP 69K / DIN 40050

Gasket

TPE moulded gasket, silicone-free

Optional: Silicone gasket

Lid screws

Stainless steel 1.4567, captive

Surface

Powder coating RAL 7040, window grey

Optional: Special colours

Optional: Corrosion protection

Customising

Learn more about our [full customising service for installation-ready enclosures](#)

Full-Service-Products

Customization according to your wishes.



Our passion is enclosures.



Expert advice

Everything begins with individual advice. We'll be pleased to support you with your project and find solutions for every requirement. Customer-specific solutions are our speciality.



Sample service

Test our products with your internal mounting. We'll be pleased to send you a sample enclosure for inspection with no strings attached.



Drilling

We'll manufacture every enclosure for you according to your exact specifications – whether they involve precise drilling or large tolerance.



Milling

Thanks to our modern CNC production, we can quickly and efficiently mill custom-fit cut-outs and contours to match your exact specifications.



Engraving

Our services also include engraving your logo and other elements, which we can of course perform in any colour you desire.



Lasering

We can process stainless steel enclosures and plates quickly and reliably according to your individual requirements thanks to our in-house lasering centre.



Powder coating

We can powder coat enclosures, command enclosures and suspension systems in any RAL colour you desire. Custom colours are of course also possible.



Painting

We can also paint all our enclosures in any RAL colour you desire. The application of primer and special colour structures are possible, as well.



Serigraphy

If desired, we can apply your logo and lettering or other markings using serigraph printing.



Digital printing

Digital printing is particularly worthwhile for low-volume orders and for realising complex patterns or images.



EMC enclosures

We offer our conFORM low-price standard EMC enclosure to protect your internal mounting against electromagnetic radiation. On request, we can also supply an EMC-compliant version of any other ROLEC enclosure.



Displays

We are able to offer the right made-to-measure display for all our enclosures – in varying sizes and degrees of robustness depending on the application.



Accessories

ROLEC's portfolio also includes matching front plates, mounting plate, supporting rails and terminal blocks as well as a range of cable glands, blanking plugs etc.



Assembly

Would you like to have all your components supplied already assembled? No problem. Our assembly team will be pleased to perform all assembly work on your behalf.



Our Service

If you have any requirements for services not listed here, please ask us. Customer-specific solutions are our speciality. We also are keen to take on unusual tasks.

We will help you with those challenges that many others would give up on.