

Suspension-system taraPLUS

Type: Tubes round Ø70

Material-No.: 144.32*.***

144.320.250 (L= 250 mm)

144.320.500 (L= 500 mm)

144.321.000 (L= 1000 mm)

144.322.000 (L= 2000 mm)

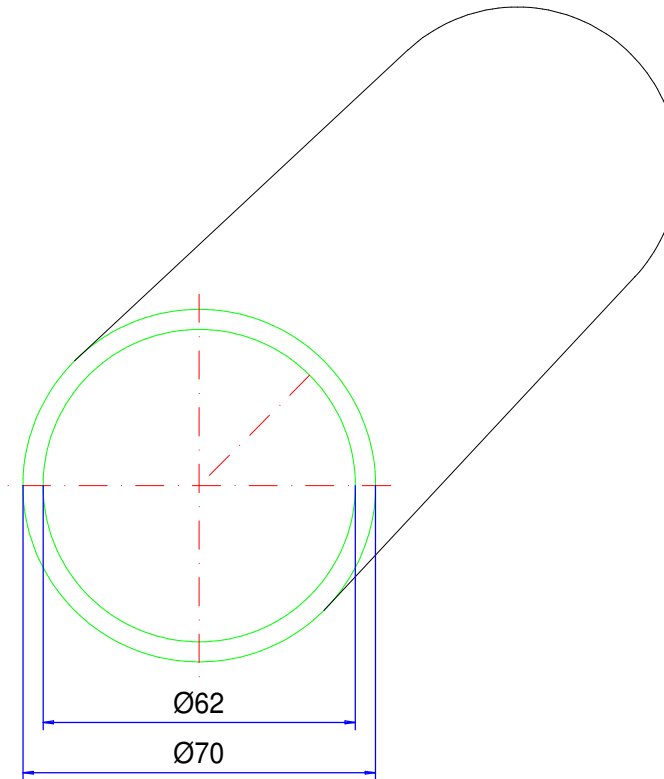

Material system elements	Steel, seamless, cold-drawn		Pivoting range	---
Gasket	---		Weight	6,900 kg/ m
Assembly screws	---		Coating	Powder coating RAL 7035, light grey
Ingress protection	IP54 EN 60529		Tolerance	EN 10305-4 (DIN 2391)

144.320.500
Round tube Ø70 500 mm



Product overview

Protection Class	IP 54/EN 60529
Color	RAL 7035
Certifications	GOST
Weight (g)	3450 g

taraPLUS

THE PROVEN SUPPORT ARM SYSTEM

IP 54

The key product features:

- Profile cross-sections: round Ø 48 and 70 mm. rectangular 40x60 mm
- System parts material: diecast aluminium, powder coating, RAL 7040
- Suspension profile material: drawn steel, powder coating, RAL 7035
- Various connections available
- Support profiles: a combination of round and/or rectangular tubes
- Various couplings available
- Simple and quick adjustment with set screws
- Can be used with all ROLEC control enclosures
- Possible to route connectors such as HDMI, patch cable, USB, etc. (not for DVI connectors)
- Gasket: chloroprene (CR)

The taraPLUS suspension arm system was developed for light to medium loads. It is quick and easy to assemble on site. The large openings in the system parts allow cables to be easily fed through. The special design combines round and square profiles, thereby achieving high static equilibrium. taraPLUS is a tried and trusted system which is tested to IP 54 protection class.

Principle

Many variants, closed system with easy access to system parts for light to medium loads.

Additional info

Simple alignment of the system

Easy installation of the cables

Special design due to the combination of rectangular and round tubes

Material/coating

System elements: Die-cast aluminium

EN AN-44300 DIN EN 1706

(GD Al Si 12/DIN 1725)

Powder coating RAL 7040, window grey

Optional: Special colours

Suspension pipes: Fe

Powder coating RAL 7035, light grey

Optional: Special colours

Bellows: PVC, RAL 7035, light grey

Cable routing

48 mm pipe = 42 mm Ø

70 mm pipe = 62 mm Ø

60/40 mm pipe = 54 x 34 mm

Ingress protection

IP 54 EN 60529

Torque for cutting ring screws

30 Nm = 3 kg/m

Full-Service-Products

Customization according to your wishes.



Our passion is enclosures.



Expert advice

Everything begins with individual advice. We'll be pleased to support you with your project and find solutions for every requirement. Customer-specific solutions are our speciality.



Sample service

Test our products with your internal mounting. We'll be pleased to send you a sample enclosure for inspection with no strings attached.



Drilling

We'll manufacture every enclosure for you according to your exact specifications – whether they involve precise drilling or large tolerance.



Milling

Thanks to our modern CNC production, we can quickly and efficiently mill custom-fit cut-outs and contours to match your exact specifications.



Engraving

Our services also include engraving your logo and other elements, which we can of course perform in any colour you desire.



Lasering

We can process stainless steel enclosures and plates quickly and reliably according to your individual requirements thanks to our in-house lasering centre.



Powder coating

We can powder coat enclosures, command enclosures and suspension systems in any RAL colour you desire. Custom colours are of course also possible.



Painting

We can also paint all our enclosures in any RAL colour you desire. The application of primer and special colour structures are possible, as well.



Serigraphy

If desired, we can apply your logo and lettering or other markings using serigraph printing.



Digital printing

Digital printing is particularly worthwhile for low-volume orders and for realising complex patterns or images.



EMC enclosures

We offer our conFORM low-price standard EMC enclosure to protect your internal mounting against electromagnetic radiation. On request, we can also supply an EMC-compliant version of any other ROLEC enclosure.



Displays

We are able to offer the right made-to-measure display for all our enclosures – in varying sizes and degrees of robustness depending on the application.



Accessories

ROLEC's portfolio also includes matching front plates, mounting plate, supporting rails and terminal blocks as well as a range of cable glands, blanking plugs etc.



Assembly

Would you like to have all your components supplied already assembled? No problem. Our assembly team will be pleased to perform all assembly work on your behalf.



Our Service

If you have any requirements for services not listed here, please ask us. Customer-specific solutions are our speciality. We also are keen to take on unusual tasks.

We will help you with those challenges that many others would give up on.